

Supplementary Material on Additional Sub-Topics included
in Class XII Physics Theory Syllabus in the Chapter on
Communication Systems for March – 2015 Examination

A. INTERNET

Introduction

Invention of computers changed the working style of people in twentieth century. Its capability to tirelessly and sequentially do arithmetical and logical operations made the human life simpler and faster. Offices, universities, banks, schools etc. nothing remained unaffected by use of computers. This was not enough and before the end of twentieth century we succeeded in creating a global network of computers that provides ways to exchange information and to communicate among all computers connected to the network. This global network of computers is what we now call Internet (or simply net). Internet, in fact, is the short form of INTER-NETwork which is the interconnected network of all worldwide servers.

Networking of computers: The way Internet works

Two or more than two computers are said to be networked when they are able to exchange information between them. This sharing of information can be through wires connecting these computers or some wireless means of communications like Wi-Fi.

Networking of computers at small scale (e.g. within an office, a building or a school) is called **Local Area networking (LAN)**. One can also connect devices like printer, scanner, etc. to a LAN as shown in the figure below.

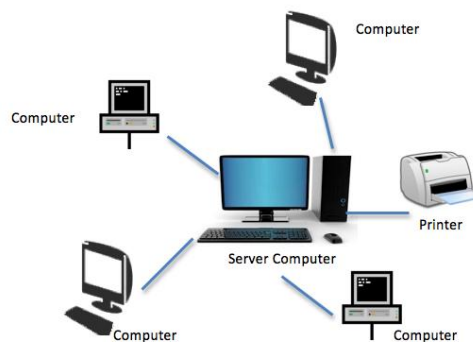

A Local Area Network (LAN)

One can build such a local area network of computers within an institution by connecting all or some of their computers. Every LAN has some main computers called server computers. These servers are used to connect LAN to other networks through telephone lines or satellites. In this way, by connecting various LAN, a **Wide Area Network (WAN)** is created as shown in the figure.

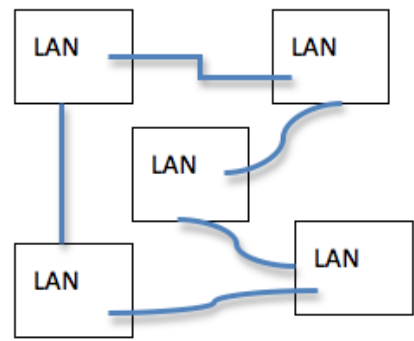

Formation of a WAN

Various interlinked WAN together constitute what we call an Internet as shown in the figure.

All information related to a local network is stored in server computers of LAN. The servers of every LAN act as channel for information exchange between computers connected to LAN and also servers of other networks. Every computer that extracts information from a server is called a **client computer**.

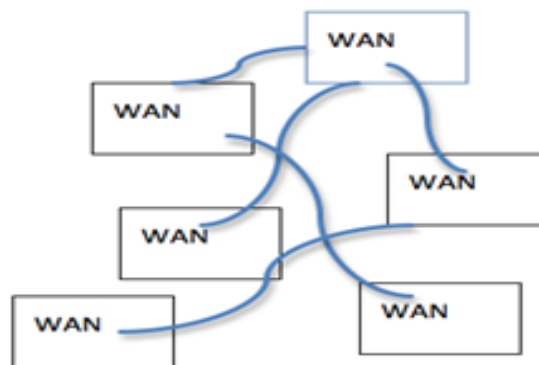

Formation of Internet

First network of computers called Advanced Research Projects Agency NETWORK (ARPANET) was developed by US Department of Defense in 1969. By 1990, many countries of the world came up with a common set of rules for Internet communication among computers called **protocols**. Nowadays, standard sets of protocols called Transmission Control Protocol/Internet Protocol (TCP/IP) are used for exchange of information through Internet.

It is important to note that the exchange of information on Internet is very fast (at the speed of light) as electronic signals (messages) of computers are communicated through electromagnetic waves.

In India, Internet was started in November 1988 by VSNL (Videsh Sanchar Nigam Limited) in Mumbai.

On Internet, information is provided / available through **webpages** that may contain text, images, videos, etc. One can move from one webpage on Internet to another through a system called interlinked hypertext documents. In this system, one webpage is linked to another webpage by providing hyperlinking (a way of highlighting) to any text, image or video. This way of accessing information on Internet through interlinking of webpage is called www or World Wide Web.

Anyone can provide specific information on Internet by making a couple of webpages containing that information. Such a set of webpages together constitute a **website**. One can design a website of own organization containing information about its different aspects and its activities.

Anyone can connect its computer to the Internet network through various **Internet Service Providers (ISP)** by paying a prescribed fee. Commonly, mobile network companies also acts as ISP.

Applications of Internet

People use Internet for many purposes like searching and viewing information on any topic of interest, for sending electronic mails (e-mails), for e-banking, e-shopping (e-commerce), e-booking (e-ticketing) etc. This list of uses of Internet is endless.

- (i) **Internet Surfing:** Moving on Internet from one webpage/website to another is called Internet surfing. It is an interesting way of searching and viewing information on any topic of interest.
- (ii) **E-mail:** E-mail means “electronic mail”. This is the most used application of Internet. E-mail is a way of sending texts written on computers through Internet. Along with text one can send images and videos too. This is cheapest and fastest way of sending messages.

For using this facility of Internet one needs to create a personal email account with an **email-Id** (identity) or **email address**. Email-Id is like an identity card (Name and address) through which people can identify and communicate to you through Internet. A few websites provides free email accounts and Ids to Internet users. These email-Ids are

password protected and thus no one other than whom it belongs can use them. Internet Service Providers (ISP) also provide email-Ids.

Every email-Id has two parts separated by a sign @ called at the rate of. For example, “prakrittyagi@gmail.com” is an email Id. Its two parts:

(i) Part before @ sign : prakrittyagi

It is personal information part. Here it denotes a name Prakrit Tyagi.

(ii) Part after @ sign : gmail.com

It is called a domain name. It provides information about the server that is providing this email facility.

A message sent through email is instantly delivered to the addressee because communication of messages is by means of electromagnetic waves through Internet. Beauty of email lies in the fact that a message is stored in an email account even at a time when its user is not connected to Internet, which can be viewed later.

Email's use is increasing day by day. We can even send personalized greeting cards through email. Today it has become an extremely popular communication tool.

(iii) **E-banking:** It is an electronic payment system allowing customers to proceed for financial transactions on a website operated by that financial institution (usually a bank). For this purpose, customer needs to be a member of that institution, needs to have internet access and must register with the institution for the service. In turn, the financial institution provides the login number and password to the customer for his/her unique identification. With the help of this facility a customer can link his account with any other facilities such as checking on line status of the balance, check book requisition, loan, recurring, credit card, debit card etc.

(iv) **E-shopping (E-commerce):** Virtual Malls are available on Internet where one can view and order to purchase various products. Buying products through product selling websites is called e-shopping. These websites provide the buyer pay cash on delivery or making online payments (using e-banking or credit cards) options. Similarly, there are websites on which one can upload (put) photographs of products, which you want to sell. This trading

of products using Internet along with many other market related activities is called e-commerce.

- (v) **E-booking (e-ticketing):** It is an application developed for ticket reservation through the Internet to help the travel and tourism industry. It helps consumers to book flight tickets, railway tickets, hotels, holiday packages, insurance and other services online.

To book an e-ticket, a customer needs to visit a home page of an Airline Company or Indian Railways. Once he/she enters the travel preference, gets an opportunity to view the available flights / trains through an appropriate interface. Once the choice is fixed, the customer needs to select the mode for transfer of money. Once the payment is done through an authentic mode (like e-banking), an online ticket is issued to the customer.

- (vi) **Social Networking:** It is a service providing a platform to the people having same interests to build a social network. It is a web-based service allows an individual to create his/her own profile, list of users with whom they want to connect. The service allows the user to share their ideas, pictures, events, activities etc. with their group. Facebook, Twitter, Google+ etc. are some popular social networking sites.

B. MOBILE TELEPHONY

Introduction

As we look around, in markets, on trains and buses, people crossing streets, we can see many individuals talking on cell phones or mobile phones. Mobile phones have changed the way we live and communicate. With advancement of technology, look and utility of mobile phone has also undergone change. In latest mobile phones, along with making and receiving phone calls one can also:

- Store contact information
- Make task or to-do lists
- Keep track of appointments and set reminders
- Use the built-in calculator for simple math
- Send or receive e-mail
- Get information (news, entertainment, stock quotes) from the Internet



- Play games
- Listen radio/music and watch TV
- Send text messages
- Take photos and videos etc.

In a way, today's mobile phone is a handy computer equipped with Internet.

In ordinary landline phones, phone instruments are connected to a telephone exchange through electric wires, which in turn connect our phone calls to the other phones. However, wire connections limit the mobility of a landline phone. Mobile phone technology has successfully overcome this limitation.

Mobile phone is a low power operated device (transmitter), which can wirelessly send and receive radio frequency signals. Before this, walkie-talkie was also a wireless system of communication. You must have seen a policeman talking on his wireless set. After completing one sentence, he says "Over" and then listens. This was because the same radio frequency is used for both sending and receiving the audio signal. However, in a mobile phone, the outgoing and incoming signals use different frequencies, so the two individuals can talk and listen at the same time.

Working principle of Mobile phone

In a mobile phone, it is possible to talk while moving. This becomes possible because of a cellular radio network technology (a replacement of telephone exchange system). Under a cellular radio network a given physical area is divided into smaller parts call cells (or cell zones). To completely cover a given area use of hexagonal cells is a best possible way as shown in the figure.

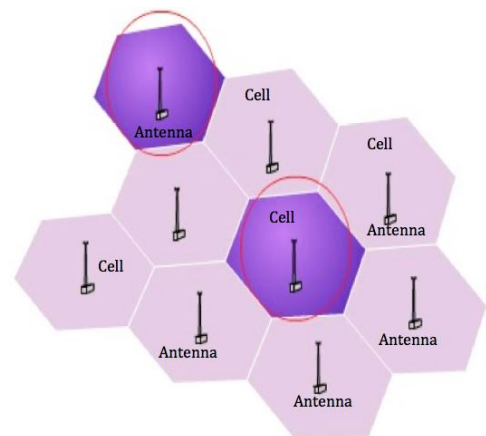

In every hexagonal cell a radio antenna is installed to receive and send radio signals to and from mobile phones physically present within the cell. All cell antennas present within an area are connected to each other through a network (the way computers are connected in internet).

All network related works including handling of all the incoming and outgoing calls are managed by a central control room called **Mobile Telephone Switching Office (MTSO)**. i.e. MTSO is basically a telephone exchange for mobile phone calls.

Every cell antenna has a working range of minimum 1.5 to 2 km and maximum up to 48 to 56 or more km area around it. When a mobile phone is switched on, MTSO records its location by identifying the cell in which it is present. When a mobile phone user moves from one cell zone to another cell zone, MTSO of its own switches mobile phone link to new cell antenna. This way, user gets an uninterrupted link to talk while on move. Also, mobile phones use high frequency radio waves for conversation. Audio signals of these waves are better. As mobile phones works on cell division of physical areas they are also referred as cell phones.

Scientific process of a mobile phone call

When we dial a mobile number from your mobile phone, an oscillator circuit (frequency generator) inside the mobile generates a particular frequency electromagnetic wave. This electromagnetic wave carrying called number's information is transmitted through antenna of your mobile to the antenna of the cell in which we are present. The cell antenna in turn transfers this signal to MTSO. The MTSO computer system identifies the location (cell) of the mobile phone you have dialed and connects you to that phone. The caller mobile on receiving your signal generates again through an oscillator circuit your ID (mobile number) and displays it. This whole process happens with in a few seconds as all the signals are transferred through electromagnetic waves, which travel at the speed of light. Here, it is important to note that mobile phone call is transferred from dialer cell antenna to MTSO and MTSO to caller cell antenna only through cell antenna lying in between. That is why mobile phone network is also called terrestrial cellular network.

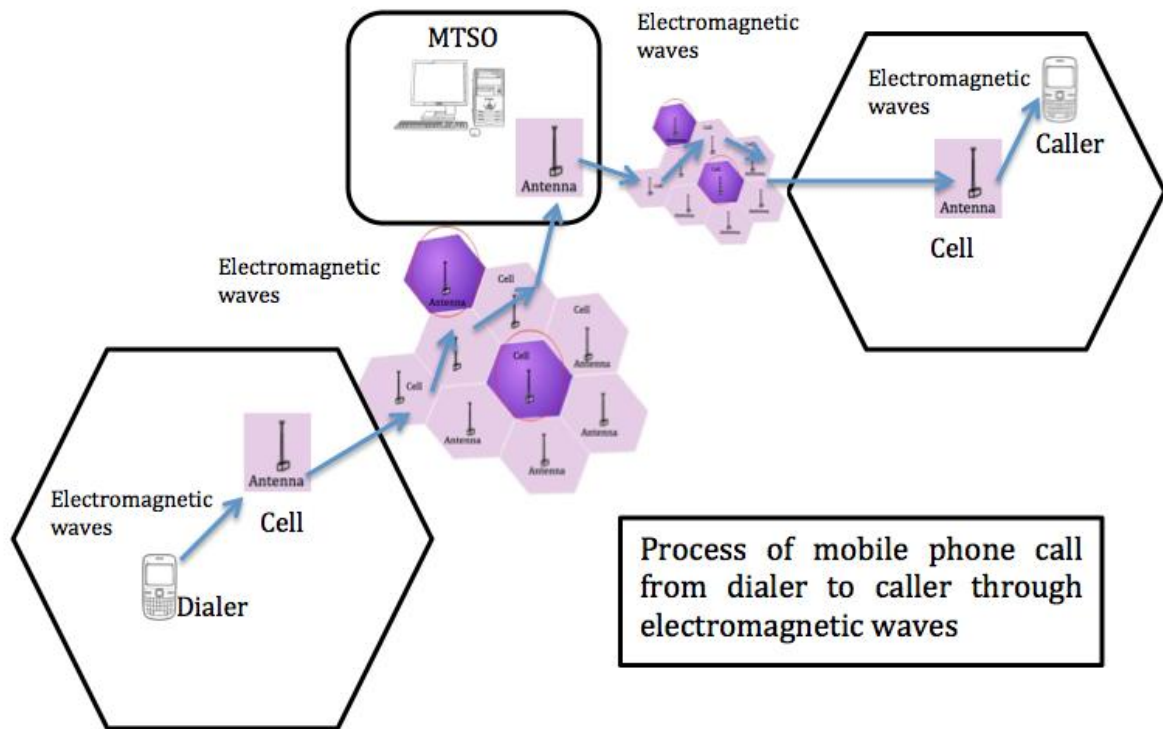

Process of mobile phone call from dialer to caller through electromagnetic waves

Mobile phone numbering system

Due to mobility of a mobile phone it is necessary to identify every mobile phone. For this, a SIM (Subscriber Identity Module) card is inserted in every mobile phone. SIM card is like an identity card of its user. It is a small IC (Integrated circuit) chip with a unique SIM number and a mobile phone number. A typical SIM card is shown in the figure. All SIM cards are issued by mobile operator companies and their information is provided to MTSO. After SIM verification, MTSO activates the mobile number of the user. This makes a mobile phone usable. Every mobile number in India is of 10 digits. All mobile numbers in India have the prefix 9,8 or 7. As per National Numbering Plan 2003, the way to split mobile numbers is as XXXX-NNNNNN where XXXX is Network operator digits and NNNNNN is the subscriber number digits. To regulate the use of mobile phones system in India a Telecom Regulatory Authority of India (TRAI) was established in 1997 by an act of Parliament.



Mobile network Generations (1G, 2G, 3G & 4G)

With increasing use of mobile phones and advancement of technology, it is pertinent to make the mobile phone networks more efficient. The efficiency of mobile networks is mentioned by word 'Generation' and abbreviation 'G'. 1G were first generation of mobile networks, which were based on analogue radio signals. 2G were narrow band digital signal based networks with good quality of calls. They provided world over connectivity. 3G networks increased the data transfer speed for efficient use of Internet on mobile phone. 4G networks are going to provide a high-speed internet facility on mobile phones for surfing net, chatting, viewing television, listening music etc.

C. Global Positioning System

Since ages man has invented various instruments to assist him in navigation on earth. Magnetic compass is one of the oldest navigational instrument man has been using for many centuries for direction identification on earth's surface. Global Positioning System (GPS) based devices are the latest navigation assistance devices used these days. GPS devices provide accurate real time location and much more information to its user for easier and comfortable navigation even through his or her local streets. A commonly available GPS device is shown in the figure. When fitted in a car, it shows speed of the car, time, longitude coordinates and map of near-by area.



What is Global Positioning System (GPS)?

Global positioning system GPS is a method of identifying location or position of any point (or a person) on earth using a system of 24 satellites, which are continuously orbiting, observing,

monitoring and mapping the earth surface. Every such satellite revolves around earth twice a day at a distance of about 20000 km from it. The given figure shows sketch view of 24 GPS satellites orbiting around the earth.

The orbits of these satellites are so aligned that at least four of them always keep looking any given point on earth surface. This is minimum necessary requirement for correct and accurate location identification through this system. In the given figure, the given location at the instant is visible to 12 satellites.

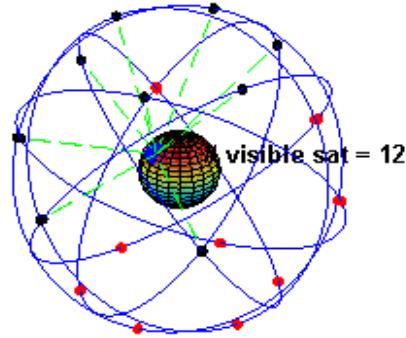

Working principle of a GPS device

For using the GPS system of satellites, a person needs a GPS device fitted with a transmitter/receiver for sending/receiving signals (electromagnetic radio waves) so that it can link up with GPS satellites in real time.

The unique location (or longitude coordinates) of a GPS user is determined by measuring its distance from at least three GPS satellites. Based on these distance measurements, the location calculations are done by the microprocessor (computing device) fitted in the GPS device.

For measuring distance of three GPS satellites from the GPS device user, the time taken by a radio signal to travel from device to satellites and back are recorded by the GPS device.

For, example, if a radio signal takes 0.140 seconds to travel back from a satellite-1 to its GPS user.

$$\begin{aligned}
 \text{Then, Distance of satellite-1 from user} &= \frac{3 \times 10^8 \text{ m/s} \times 0.140 \text{ s}}{2} \\
 &= \frac{3 \times 10^8 \times 0.140}{2} \\
 &= \frac{42000000}{2} \\
 &= 21000 \text{ km}
 \end{aligned}$$

Following the above method, let D_1 , D_2 and D_3 be the distances of three satellites from a GPS device user. From this information, the identification of unique location of the GPS device user is done as follows:

- (1) If user is at a distance " D_1 " from satellite-1. Then user's location can be anywhere on a circumference of circle of radius " D_1 " from satellite-1 as shown in fig below.

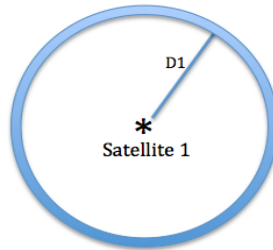

- (2) If user is at a distance " D_2 " from satellite-2. Then user's location can be either at intersecting points X or Y of circumferences of circles of radius D_1 and D_2 from satellite-1 and 2 respectively as shown in figure below.

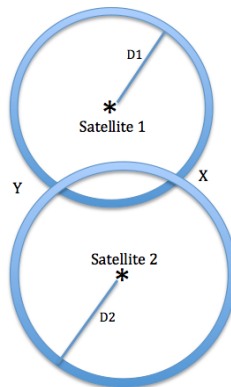

- (3) If user is at a distance " D_3 " from satellite-3. Then user's location will be at the intersecting point of circumferences of circles of radius D_1 , D_2 and D_3 from satellite-1, 2 and 3 respectively as shown in fig(c). i.e. here user is at point Y.

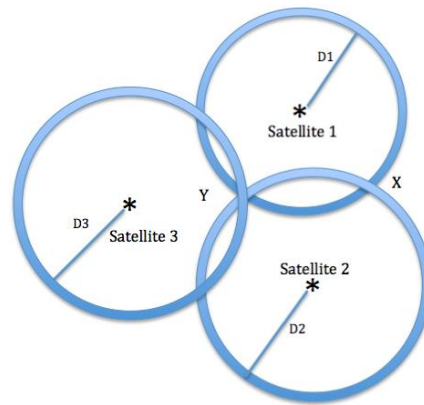

This way, minimum three satellites together provide the exact location (longitude coordinates) of the GPS device user on his display board.

If a person is at some height on earth surface, then using distance information from minimum 4-GPS satellites even altitude of the user can also be measured.

It may be noted that since all 24-GPS satellites orbit in predefined orbits, therefore their locations are precisely predetermined. It is these known locations of 3 or 4 -GPS satellites (3 or 4 sets of longitude coordinates) and their distances to GPS device that assist a GPS user (i.e. its computing device) in locating its own longitude coordinates.

Applications of GPS

Global positioning system has many day-to-day applications:

- It helps in navigation on water, air and land.
- It assists in map designing of a location.
- It helps automatic vehicle movements (without man)
- One can measure speed of moving object using this technology.
- One can locate change in position of glaciers, mountains heights.
- It assists in keeping standard time world over.
- It assists in tracking animals and birds and studying their movements by attaching GPS devices to their bodies.
- It assists in airplane traffic movement.
- It assists visually impaired in location identification.

Now-a-days, various devices like mobile phones, i-pad etc. come equipped with pre-loaded geographical maps and GPS software which identifies the location of these devices using GPS system. GPS is a free service available to anyone in the world with a GPS device.